

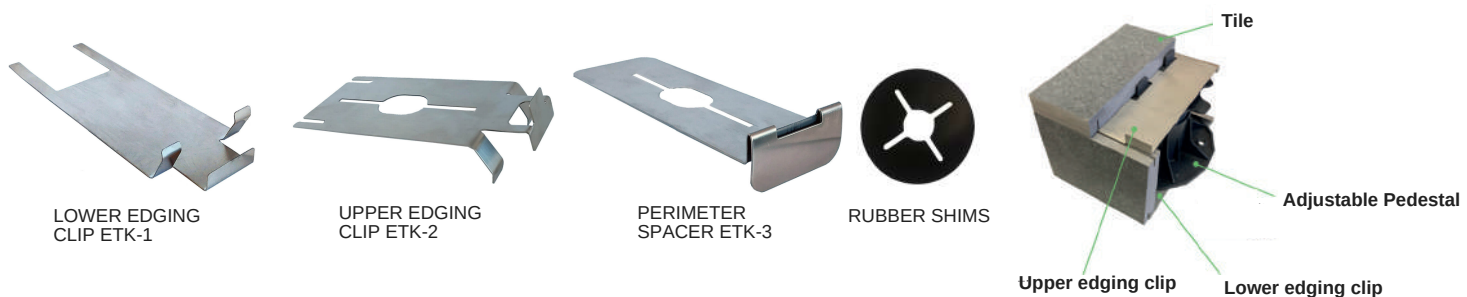







TILES ADJUSTABLE PEDESTALS ETP

PEDESTAL	TECHNICAL DATA	METHOD OF PACKAGING
ETP 18-32mm	<p>grout thickness 3mm max load < 200kg</p>	<p>Package - 50 x 51 x 34 Amount in package - 120 pcs. Weight of package - 19kg Weight of 1pcs. - 0.16kg</p>
ETP 35-70mm	<p>grout thickness 3mm max load < 200kg</p>	<p>Package - 50 x 65 x 19 Amount in package - 48 pcs. Weight of package - 9kg Weight of 1pcs. - 0.19kg</p>
ETP 66-145mm	<p>grout thickness 3mm max load < 200kg</p>	<p>Package - 50 x 65 x 31 Amount in package - 48 pcs. Weight of package - 12.5kg Weight of 1pcs. - 0.26kg</p>
ETP 140-220mm	<p>grout thickness 3mm max load < 200kg</p>	<p>Package - 50 x 66 x 33 Amount in package - 24 pcs. Weight of package - 8kg Weight of 1pcs. - 0.33kg</p>

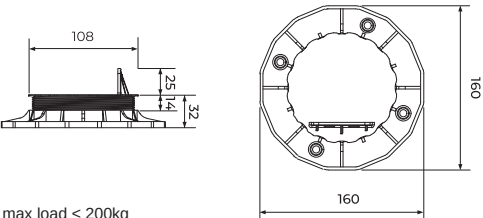
Lower edging clip, upper edging clip and perimeter spacer - stainless steel

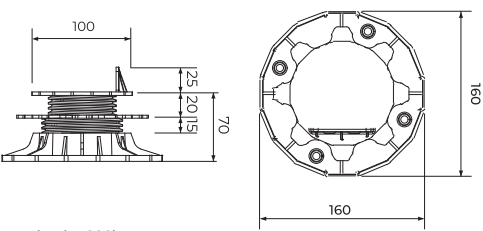

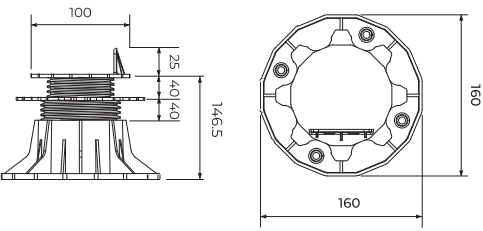

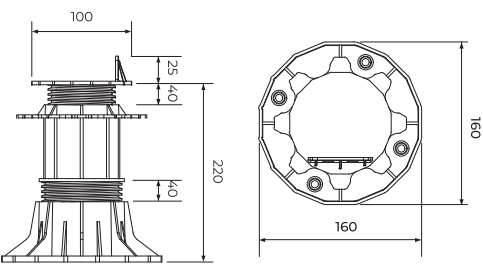



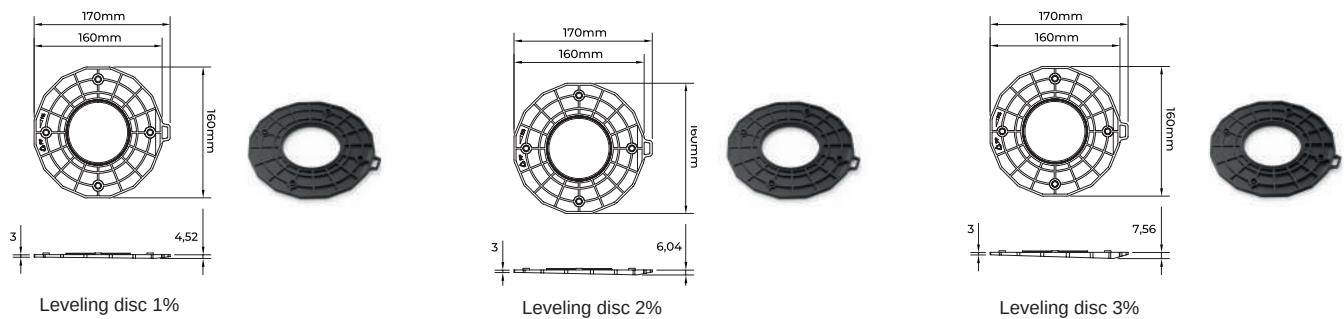

TILES ADJUSTABLE PEDESTALS ETL

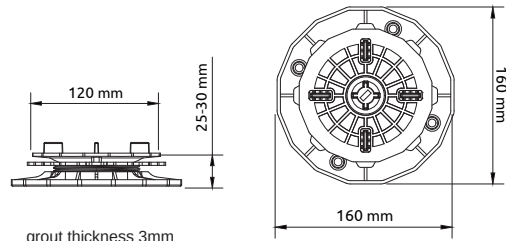
PEDESTAL		TECHNICAL DATA	METHOD OF PACKAGING
ETL 18-32mm		 <p>max load < 200kg</p>	<p>Package - 50 x 51 x 34 Amount in package - 120 pcs. Weight of package - 19kg Weight of 1pcs. - 0.16kg</p>
ETL 35-70mm		 <p>max load < 200kg</p>	<p>Package - 50 x 65 x 19 Amount in package - 48 pcs. Weight of package - 9kg Weight of 1pcs. - 0.19kg</p>
ETL 66-145mm		 <p>max load < 200kg</p>	<p>Package - 50 x 65 x 31 Amount in package - 48 pcs. Weight of package - 12.5kg Weight of 1pcs. - 0.26kg</p>
ETL 140-220mm		 <p>max load < 200kg</p>	<p>Package - 50 x 66 x 33 Amount in package - 24 pcs. Weight of package - 8kg Weight of 1pcs. - 0.33kg</p>

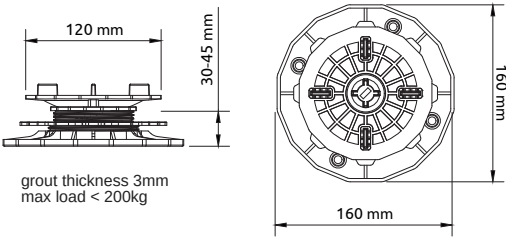
Leveling discs suitable for ETL and ETP pedestals with a slope of 1%-3%

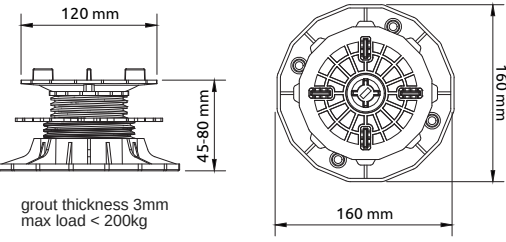

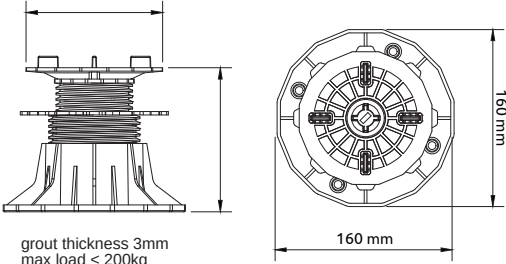
SELF-LEVELING TILES ADJUSTABLE PEDESTALS ETP FLEX

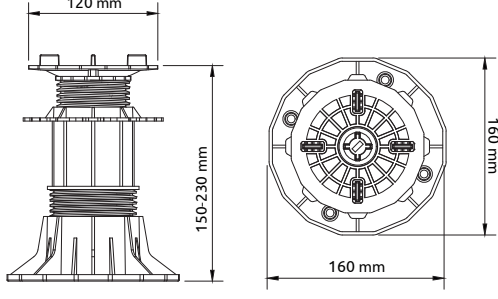
PEDESTAL		TECHNICAL DATA	METHOD OF PACKAGING
ETP FLEX 25-30 mm		 <p>grout thickness 3mm max load < 200kg</p>	<p>Package - 66 x 50 x 29 Amount in package - 96 pcs. Weight of package - 14.5kg Weight of 1pcs. - 0.15kg</p>
ETP FLEX 30-45 mm		 <p>grout thickness 3mm max load < 200kg</p>	<p>Package - 67 x 50 x 26 Amount in package - 72 pcs. Weight of package - 12.3kg Weight of 1pcs. - 0.17kg</p>
ETP FLEX 45-80 mm		 <p>grout thickness 3mm max load < 200kg</p>	<p>Package - 66 x 50 x 26 Amount in package - 48 pcs. Weight of package - 10.2kg Weight of 1pcs. - 0.17kg</p>
ETP FLEX 75-156 mm		 <p>grout thickness 3mm max load < 200kg</p>	<p>Package - 66 x 50 x 36 Amount in package - 48 pcs. Weight of package - 13.85kg Weight of 1pcs. - 0.29kg</p>
ETP FLEX 150-230 mm		 <p>grout thickness 3mm max load < 200kg</p>	<p>Package - 66 x 50 x 35 Amount in package - 24 pcs. Weight of package - 8.6kg Weight of 1pcs. - 0.36kg</p>

ACCESSORIES



3 MM RUBBER SHIM



ADJUSTING KEY